

Advantages

- High reliability
- For large current
- Low cost

Open Loop Type

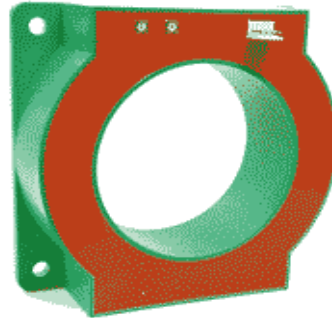

Specifications

Ta=25°C

Product name	Code:2502		CDA-2000
	Symbol	Unit	
Nominal input current	If(n)	AT	±2000
Saturation current	If(s)	AT	±2200
Nominal Output Voltage	Vh	V	±10±1% [at If(n)]
Load resistance	RL	Ω	10k
Offset Voltage	Vo	V	0±0.030 [at 0A]
Supply Voltage	Vcc	V DC	±15±5%
Consumption Current	Icc	mA	±35 Max.
Response Speed	Trr	μ sec	7 Max. [at di/dt=100A/μ sec]
Thermal Drift of Vh		%/°C	±0.08 Max. [at If(n)]
Thermal Drift of Vo		mV/°C	±1 Max. [at 0A]
Dielectric Strength		kV	AC 2.5 [with 50 or 60 Hz 1min.]
Insulation Resistance		Ω	500M Min. [at 500V DC]
Operating Temperature	Ta	°C	-20 to +80
Storage Temperature	Ts	°C	-25 to +85
Hysteresis Error		mV	50 Max. [at If --> 0]

Dimensions

Unit : mm

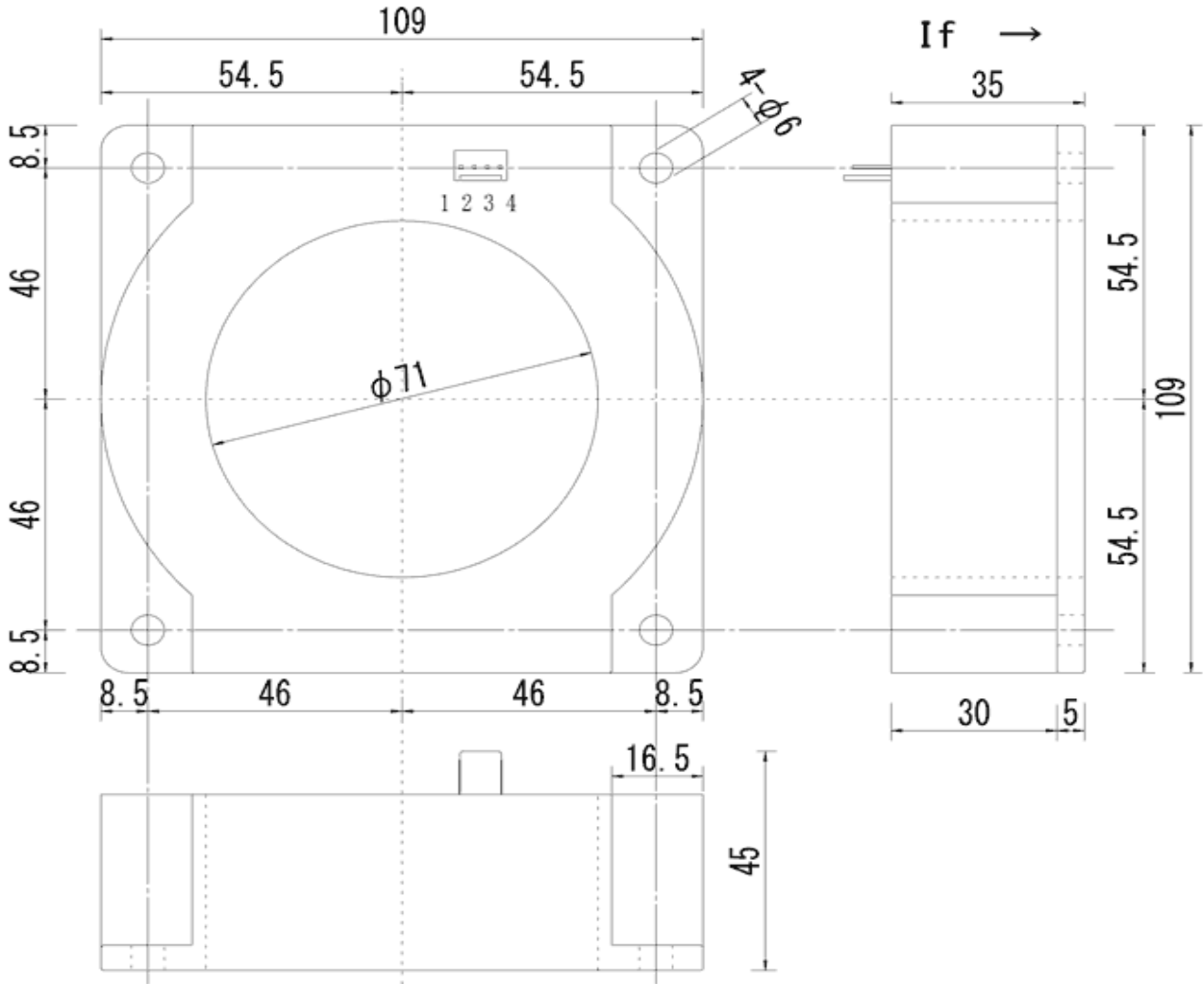

Connector Type[22-11-1041] Maker[Molex]

CDA-21029

Product Name	Mass
CDA-2000	830g

Connection



NANA ENGINEERING CO.,LTD.
ENGINEERING

1-22-5,Morino,Machida-shi,Tokyo 194-0022
Machida 310 Irago building 4F
E-Mail : nanaeng_sales@nana-e.com
URL : <http://www.nana-e.com>