

## Advantages

- Low thermal drift
- Extended measuring range
- Voltage detector for AC and DC
- Excellent linearity
- Completely insulated from the primary side

## Open Loop Type



## Specifications

Ta=25°C

Product name	Code:2271		HVT-50
	Symbol	Unit	
Nominal input Voltage	Vin	V	±50
Saturation Voltage	Vin(s)	V	±75
Nominal Output Voltage	Vout	V	±4±0.080 [at Vin]
Offset Voltage	Vo	V	0±0.030 [at 0V]
Supply Voltage	Vcc	V DC	±15±5%
Consumption Current	Icc	mA	±25 Max.
Response Speed	Trr	μ sec	50 Max.
Thermal Drift of Vh		%/°C	Within±0.08 [at V=V(in)]
Thermal Drift of Vo		mV/°C	Within ±1.5 [at V=0]
Dielectric Strength		kV	AC 2.5 [with 50 or 60 Hz 1min.]
Insulation Resistance		Ω	500M Min. [at 500V DC]
Operating Temperature	Ta	°C	-20 to +70
Storage Temperature	Ts	°C	-25 to +85

Dimensions

Unit : mm

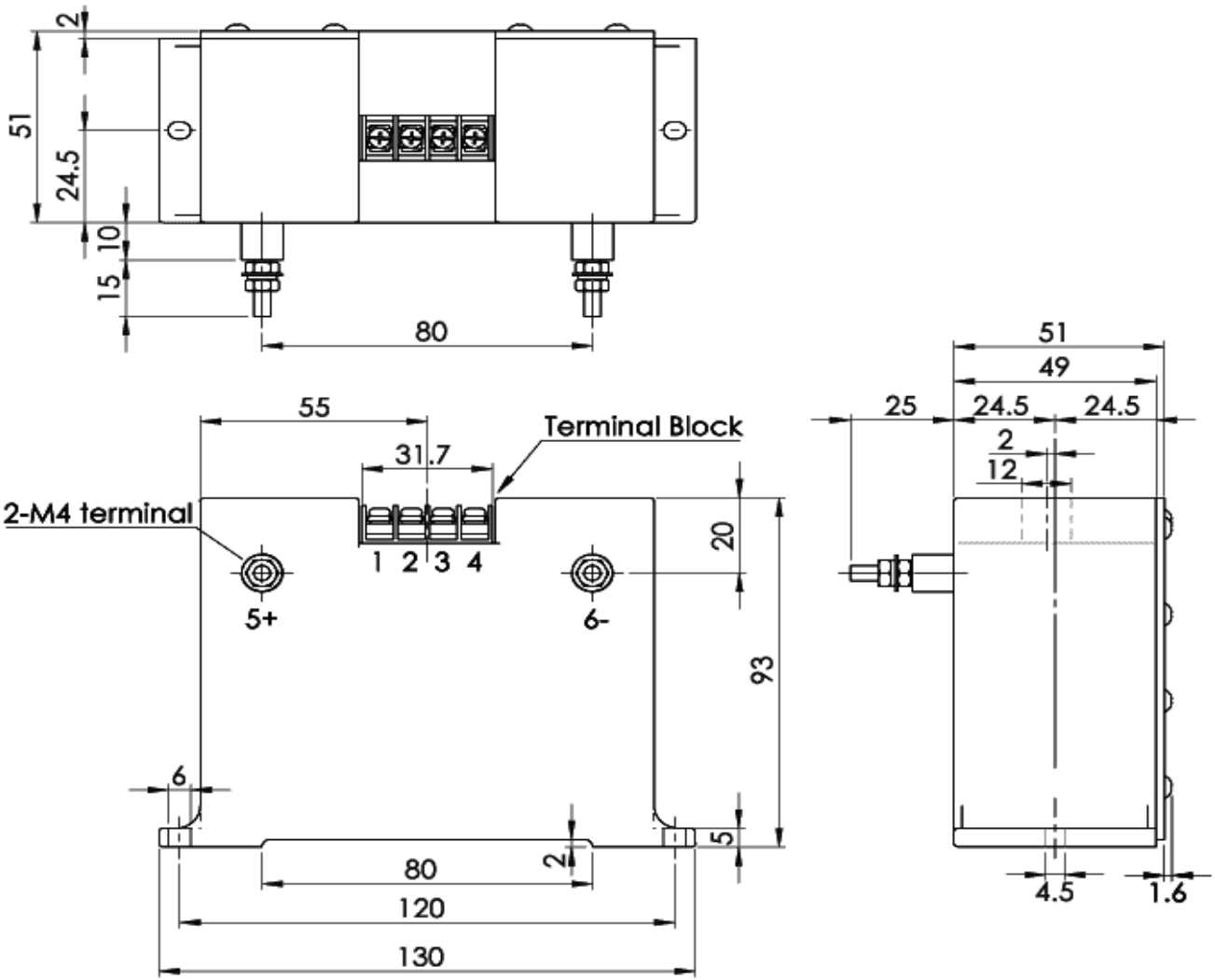

Terminal Block Type[F2060AX-4P(M3)] Maker[FUJICON]

HVT-21035

Product Name	Mass
HVT-50	316g

Connection

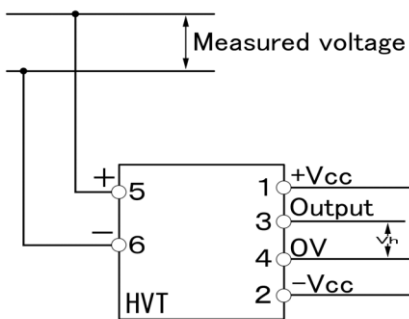

**NANA** ENGINEERING CO.,LTD.

1-22-5,Morino,Machida-shi,Tokyo 194-0022  
 Machida 310 Irago building 4F  
 E-Mail : nanaeng\_sales@nana-e.com  
 URL : <http://www.nana-e.com>