

Advantages

- Low thermal drift
- Extended measuring range
- Voltage detector for AC and DC
- Excellent linearity
- Completely insulated from the primary side

Closed Loop Type



Specifications

Ta=25°C

Product name	Code:2254		HVT-C300
	Symbol	Unit	
Nominal input Voltage	Vin	V	±300
Saturation Voltage	Vin(s)	V	±420
Nominal Output current	Iout	mA	±25 [at Vin]
Offset current	I0	mA	0±0.15 [at 0V]
Supply Voltage	Vcc	V DC	±15±5%
Consumption Current	Icc	mA	18 + Iout
Response Speed	Trr	μ sec	50 Max.
Thermal Drift of Iout		mA	Within±0.35 [at between Ta=0 to 70°C]
Thermal Drift of I0		mA	Within±0.5 [at between Ta=0 to 70°C]
Dielectric Strength		kV	AC 2.5 [with 50 or 60 Hz 1min.]
Insulation Resistance		Ω	500M Min. [at 500V DC]
Operating Temperature	Ta	°C	0 to +70
Storage Temperature	Ts	°C	-25 to +85
Measuring resistance	Rm	Ω	30~100

Dimensions

Unit : mm

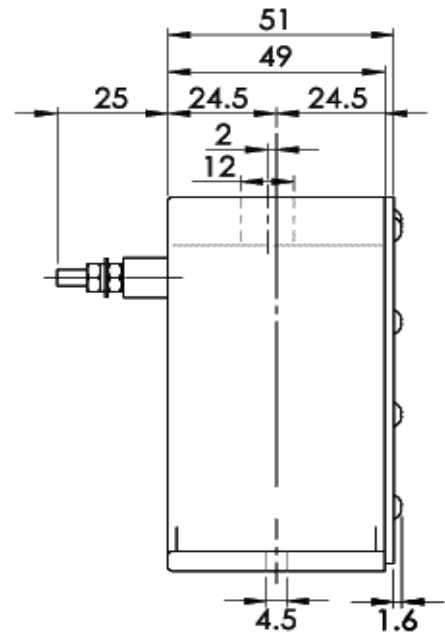
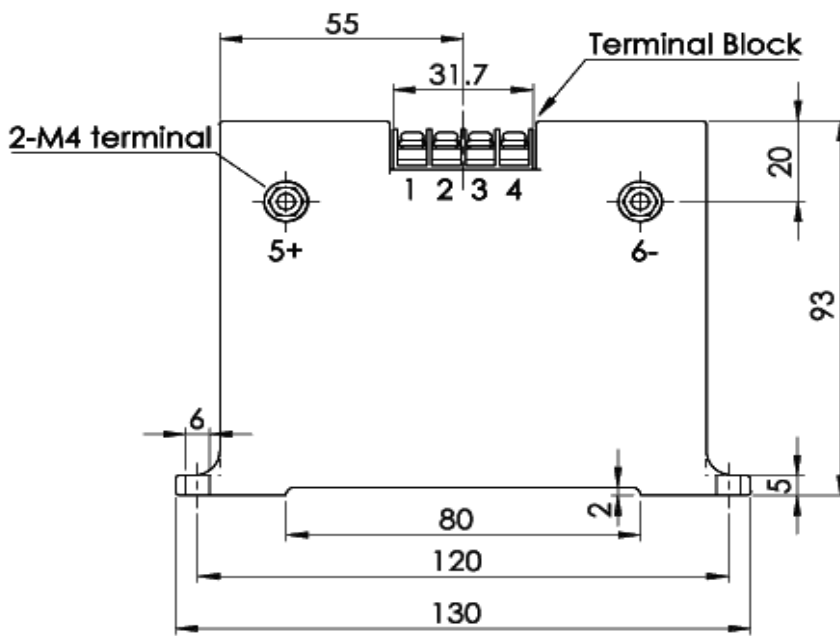
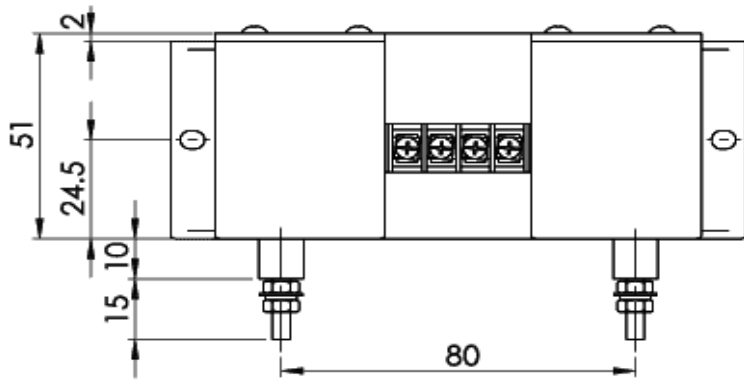

Terminal Block Type[F2060AX-4P(M3)] Maker[FUJICON]

HVT-21035

Product Name
HVT-C300

Connection

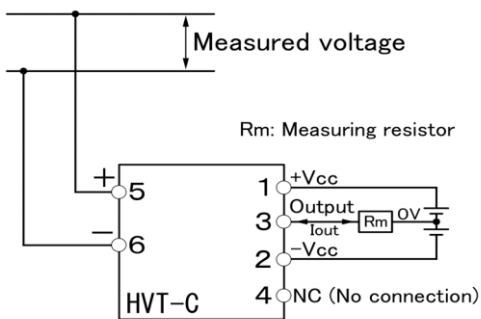

NANA ENGINEERING CO.,LTD.

1-22-5,Morino,Machida-shi,Tokyo 194-0022
Machida 310 Irago building 4F
E-Mail : nanaeng_sales@nana-e.com
URL : <http://www.nana-e.com>