

Features

- High reliability
- For large current
- Low power consumption
- Extended measuring range
- Dual output (the sama circuit) built-in

Open Loop Type



Specifications

Ta=25°C

Product name	Code:1925		CTH-06K
	Symbol	Unit	
Nominal input current	If(n)	A	±6000
Saturation current	If(s)	A	±6600
Nominal Output current	Iout	mA	±24±0.48 [at If(n)]
Load resistance	RL	Ω	250
Offset current	Io	mA	±0.20 [at 0A]
Supply Voltage	Vcc	V DC	±15±5%
Consumption Current	Icc	mA	(30+Iout)+(30+Iout)(dual circuit)
Response Speed	Trr	μ sec	100 Max. [at di/dt=100A/μ sec]
Thermal Drift of Iout		%/°C	±0.1 Max. [at If(n)]
Thermal Drift of Io		mA/°C	±0.01 Max. [at 0A]
Dielectric Strength		kV	AC 2.5 [with 50 or 60 Hz 1min.]
Insulation Resistance		Ω	500M Min. [at 500V DC]
Operating Temperature	Ta	°C	-20 to +80
Storage Temperature	Ts	°C	-25 to +85
Hysteresis Error		mA	±0.2 Max. [at If --> 0]

Dimensions

Unit : mm

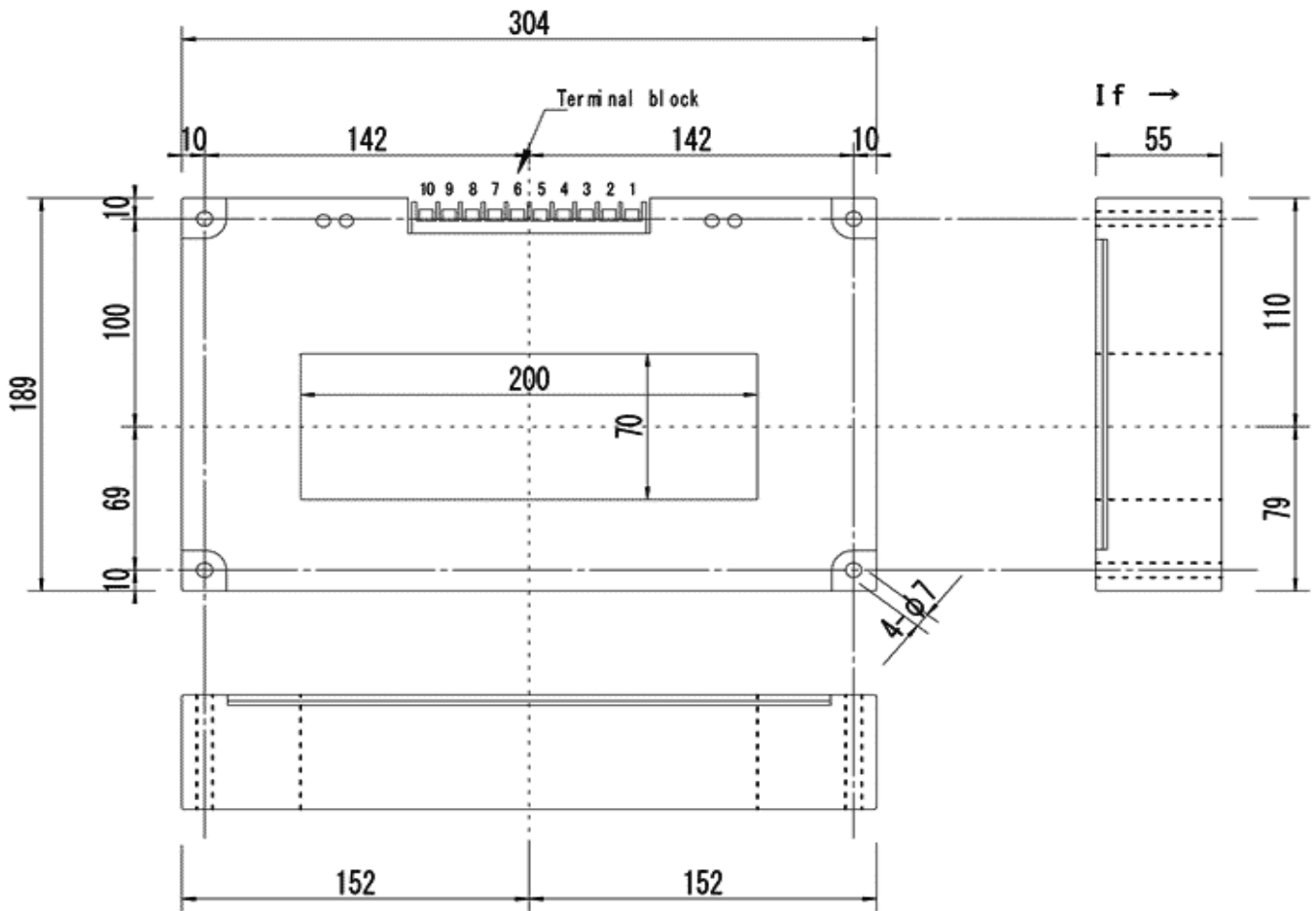

Terminal Block Type[F2010(M4)] Maker[FUJICON]

CTH-21031

Product Name	Mass
CTH-06K	6.6kg

Connection

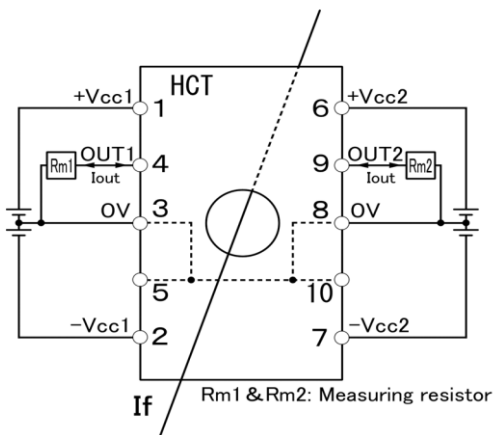

NANA ENGINEERING CO.,LTD.

Machida 310 Irago building 4F
 1-22-5 Morino, Machida-shi, Tokyo 194-0022
 E-Mail : nanaeng_sales@nana-e.com
 URL : <http://www.nana-e.com>