

## Advantages

- Compact and lightweight
- Low power consumption
- Extended measuring range
- Low cost

Open Loop Type

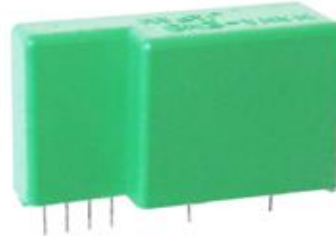

## Specifications

Ta=25°C

Product name	Code:1012		CX-25
	Symbol	Unit	
Nominal input current	If(n)	A	±25
Saturation current	If(s)	A	±63
Nominal Output Voltage	Vh	V	±4±0.040 [at If(n)]
Load resistance	RL	Ω	10k
Offset Voltage	Vo	V	0±0.040 [at 0A]
Supply Voltage	Vcc	V DC	±15±5%
Consumption Current	Icc	mA	±18 Max.
Response Speed	Trr	μ sec	2 Max. [at di/dt=100A/μ sec]
Thermal Drift of Vh		%/°C	±0.08 Max. [at If(n)]
Thermal Drift of Vo		mV/°C	±1.5 Max. [at 0A]
Dielectric Strength		kV	AC 2.5 [with 50 or 60 Hz 1min.]
Insulation Resistance		Ω	500M Min. [at 500V DC]
Operating Temperature	Ta	°C	-20 to +80
Storage Temperature	Ts	°C	-25 to +85
Hysteresis Error		mV	±20 Max. [at If --> 0]

Dimensions

Unit : mm

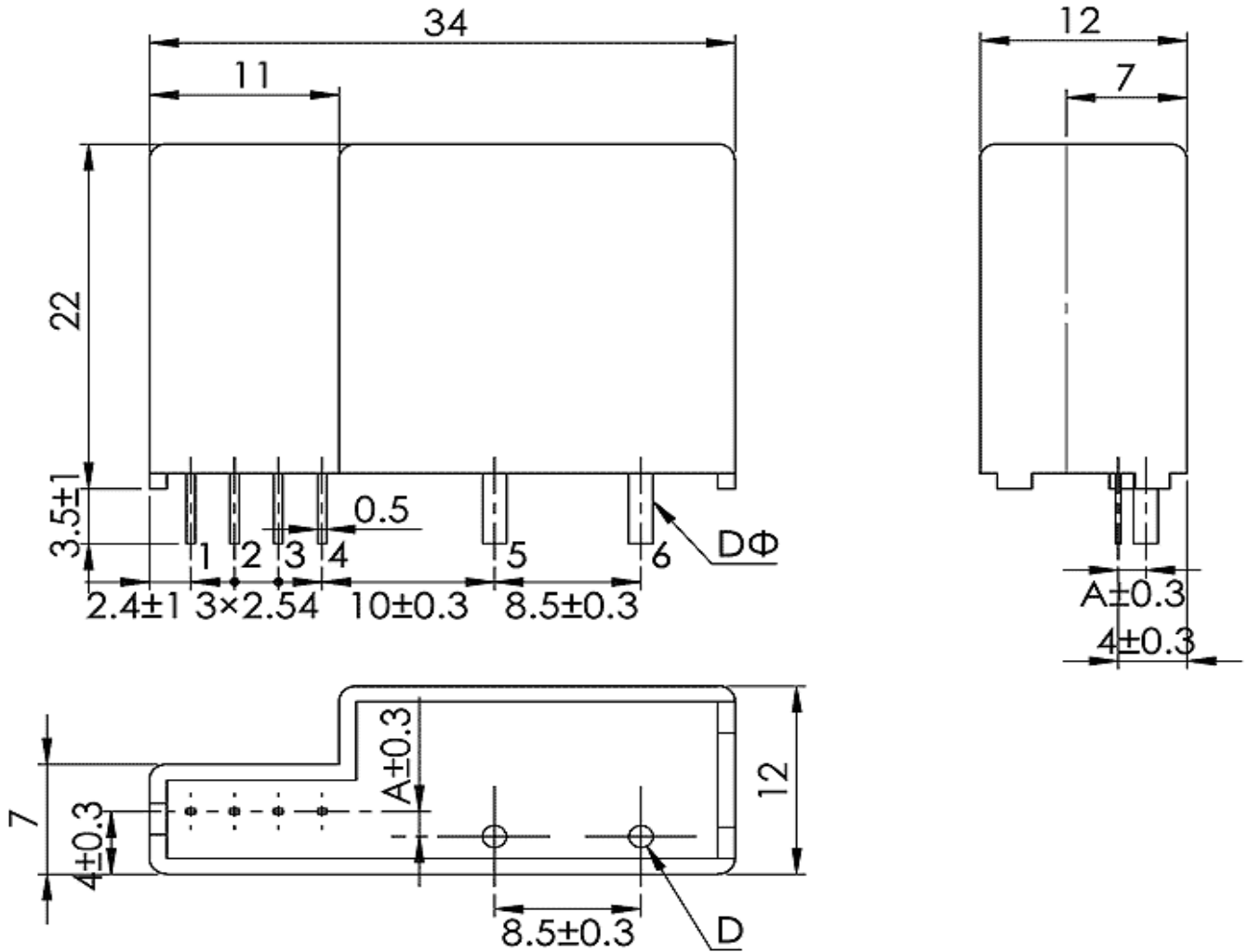

CX-21033

Product Name	Mass	Dφ	A
CX-25	15g	1.6	1.7

Connection

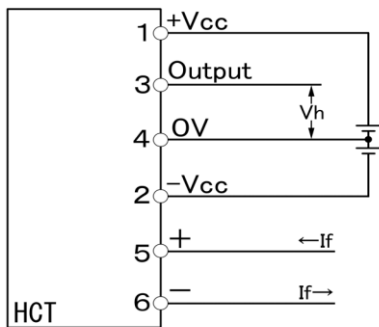

**NANA** ENGINEERING CO.,LTD.

1-22-5, Morino, Machida-shi, Tokyo 194-0022  
 Machida 310 Irago building 4F  
 E-Mail : nanaeng\_sales@nana-e.com  
 URL : <http://www.nana-e.com>